

Specification

Dimension (mm)

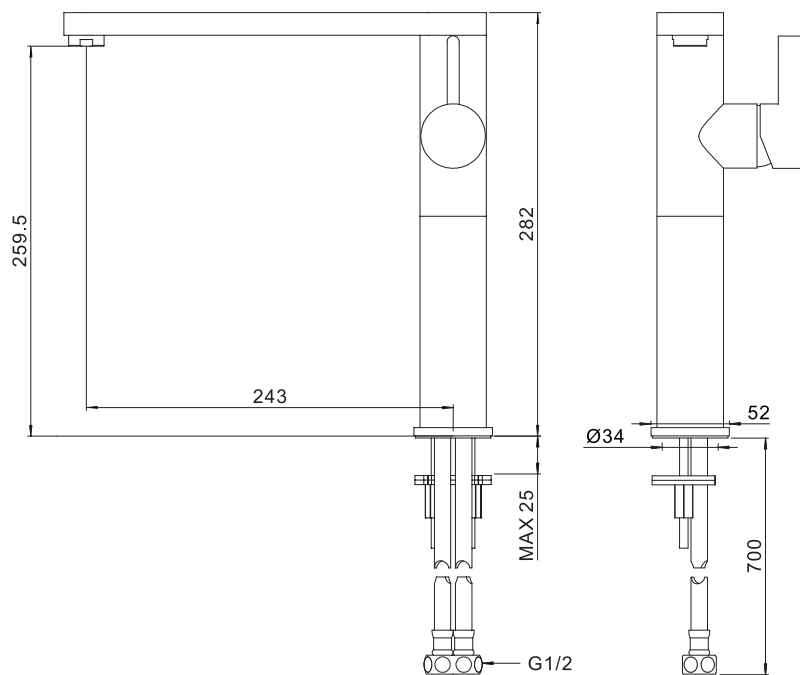

Care Instructions

Please read the following care instructions because damage to the surface and underlying material resulting from improper treatment is not covered by warranty. Do not use any abrasive sponges or scouring agents for cleaning. We also advise you not to use cleaning agents containing solvent or acid, limescale removers, household vinegar and cleaning agents with acetic acid in them. They are aggressive to the surface - and will leave your fitting dull and scratched. Clean the fitting with a little soap and a moist cloth only, then simply rinse off and wipe dry. You can avoid lime spots by drying the fitting each time it is used.

Lifetime Limited Warranty

Warranty period: 2 years from the date of purchase.
Warranty card and proof of purchase, such as the bill of sale is mandatory when requesting warranty service.
JOEL reserves the right to designate a representative to inspect the faucet for analysis.
Warranty service does not extend to the followings:
Due to the occurrence of events of force majeure, such as fire, flood, storm, typhoon, lightning, earthquake or external damage such as acid and alkali liquid, vandalism, or other natural disasters and uncontrollable incidents.
Damages caused by the parts from the third-party which are unauthorized installation, addition, extension, modification or repair.

JOEL

Basin Faucet Installation Guide

B12-S51013

EN

2021/03 V01

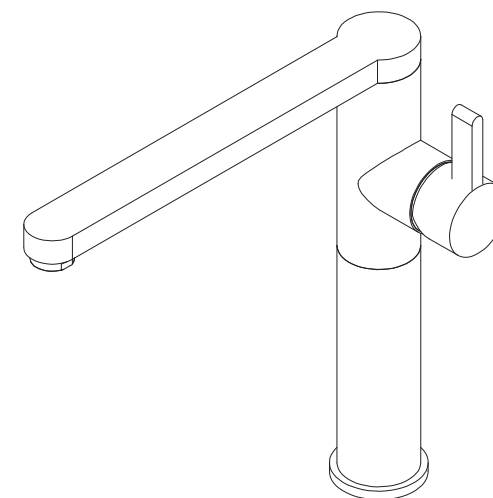

Single lever basin mixer

Material

- Ceramic cartridge exceed industry longevity standards.
- Premium metal construction.
- Finishes resist corrosion and tarnishing.

Accessories

- Push pop-up waste set with overflow.
- P-trap included.

Installation

- Single-hole installation.
- Flexible connection hoses.

Water pressure & flow rate

- Recommended 1 ~ 5 bar.
- 3.5 l/min at 3 bar.

Notes

Install this product according to the installation guide.

Installation

- 1 Turn on the hot and cold water supply valves. Make impurities to come out from water supply pipes. And then turn off the water supply valves.

NOTE:
Avoid scald. Turn off the water heater before turn on the water supply valves.

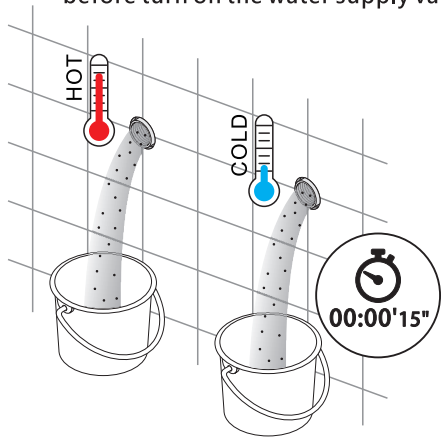

- 3 Install the pop-up drain on sink.

NOTE:
The pop-up with overflow function. Please make sure your sink with overflow function.

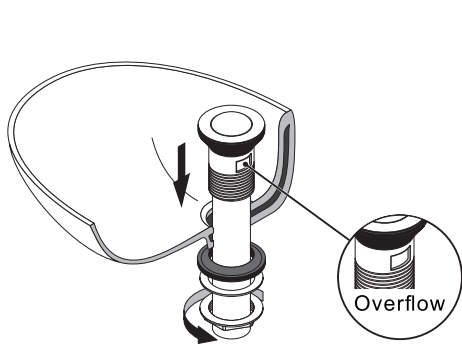

- 2 Install the angle valves on water pipes with pipe tape.

NOTE:
After installation, please check for leakage.

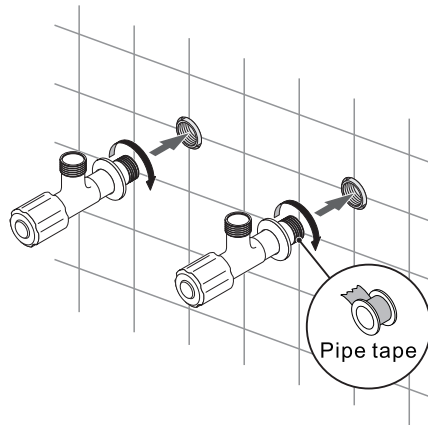

- 4 Install the P-trap into the wall.

NOTE:
After installation, please check for leakage.

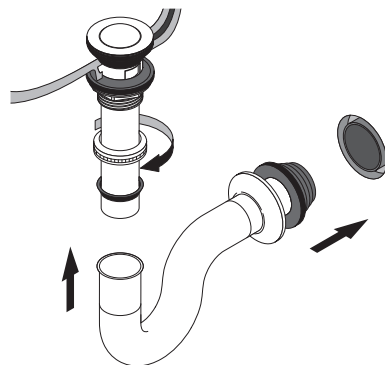

Installation

- 5 Install two long screws into the faucet from bottom. And make sure the rubber washer or O-ring on the bottom of faucet base.



- 6 Tighten the supply hoses on the faucet from bottom.

NOTE:
Please note to posit the supply hose with red symbol onto correct side.

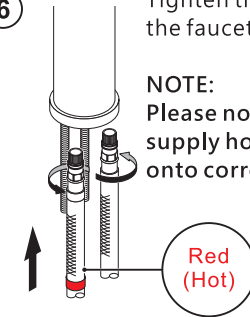

- 7 Put the supply hoses into the hole (Ø35mm) of sink. Install lock nuts with metal washer and rubber washer onto the long screws from bottom of sink.

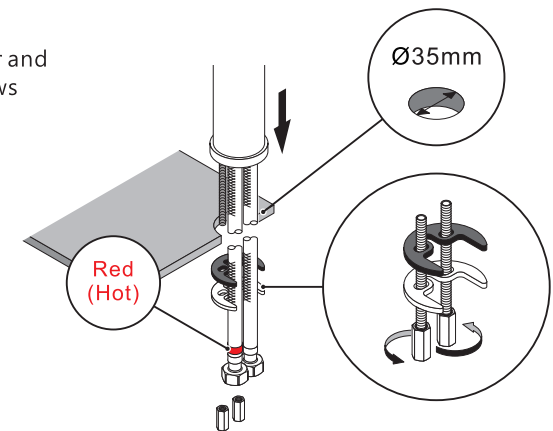

- 8 Screw the supply hoses on the angle valves.

NOTE:
Posit the supply hose with red symbol on the angle valve of hot water.

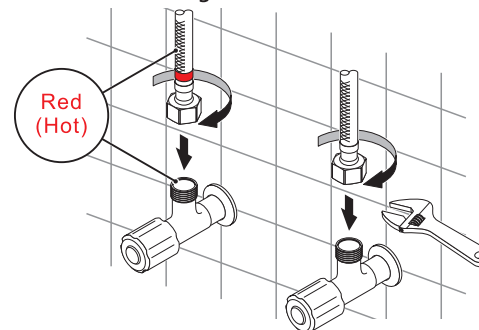

- 9 Turn on the faucet to let water comes out few minutes.

NOTE:
Turn off the faucet to check the angle valves, supply hoses and faucet for leakage.

