

Specification

Dimension (mm)

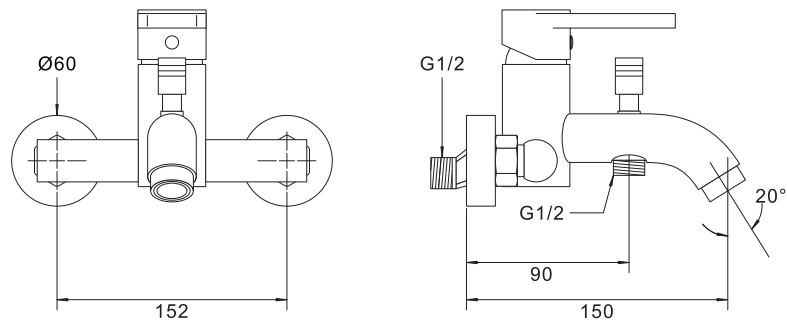

Care Instructions

Please read the following care instructions because damage to the surface and underlying material resulting from improper treatment is not covered by warranty. Do not use any abrasive sponges or scouring agents for cleaning. We also advise you not to use cleaning agents containing solvent or acid, limescale removers, household vinegar and cleaning agents with acetic acid in them. They are aggressive to the surface - and will leave your fitting dull and scratched. Clean the fitting with a little soap and a moist cloth only, then simply rinse off and wipe dry. You can avoid lime spots by drying the fitting each time it is used.

Lifetime Limited Warranty

Warranty period: 2 years from the date of purchase.
Warranty card and proof of purchase, such as the bill of sale is mandatory when requesting warranty service.
JOEL reserves the right to designate a representative to inspect the faucet for analysis.
Warranty service does not extend to the followings:
Due to the occurrence of events of force majeure, such as fire, flood, storm, typhoon, lightning, earthquake or external damage such as acid and alkali liquid, vandalism, or other natural disasters and uncontrollable incidents.
Damages caused by the parts from the third-party which are unauthorized Installation, addition, extension, modification or repair.

JOEL

Bath Faucet Installation Guide

B11-S43032

EN

2021/03 V01

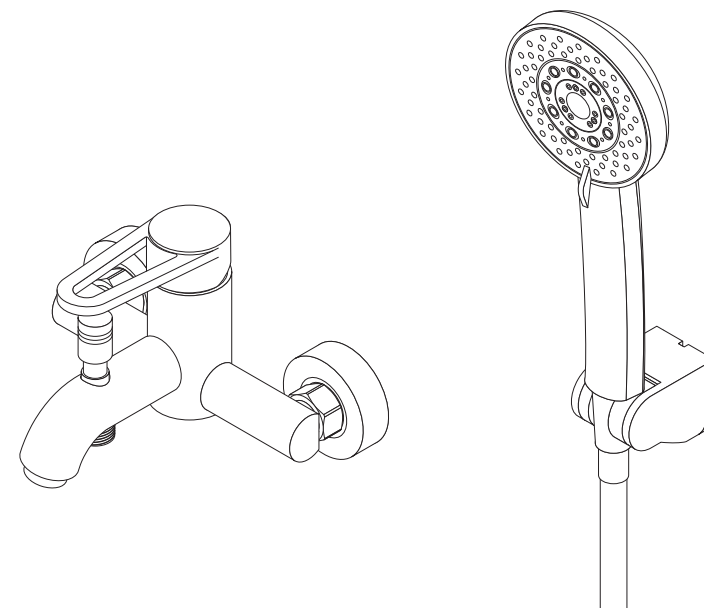

Bath Faucet

Material

- Ceramic cartridge exceed industry longevity standards.
- Premium metal construction.
- Finishes resist corrosion and tarnishing.

Installation

- Wall-mount installation.
- S-shaped connections.
- 150 ± 10 mm center distance.
- Easy installation.

Water pressure & flow rate

- Recommended 1 ~ 5 bar.
- Bath spout flow rate 22 l/min at 3 bar.
- Hand shower flow rate 26 l/min at 3 bar.

Notes

Install this product according to the installation guide.

Installation

- 1 Turn on the hot and cold water supply valves. Make impurities to come out from water supply pipes. And then turn off the water supply valves.

NOTE:
Avoid scald. Turn off the water heater before turn on the water supply valves.

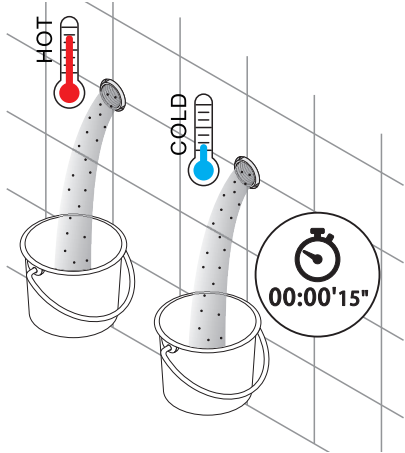

- 2 Install the S-connections on water pipes with pipe tape.

NOTE:
Make sure to be level.

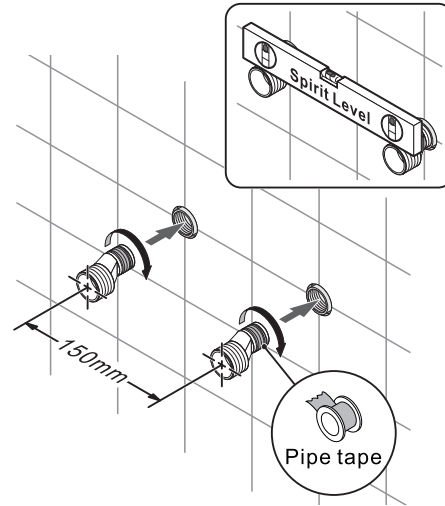

- 3 Install the decorative covers on S-connections. Put the rubber washers into faucet adapter. Install the faucet on S-connections.

NOTE:
After installation, turn on the hot and cold water supply valves. Turn off the faucet to check the S-connection and faucet for leakage.

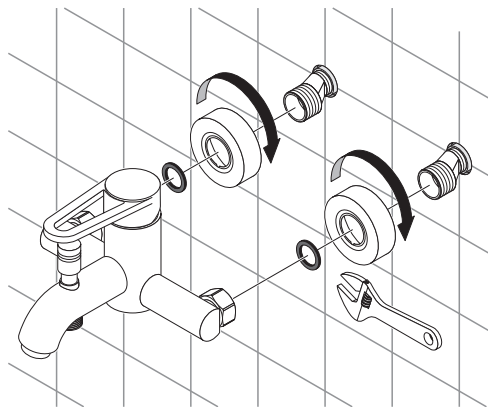

Installation

- 4 Install the shower holder on the wall.
- 5 Install the shower hose to connect faucet and hand shower.

NOTE:
Check for the rubber washers.

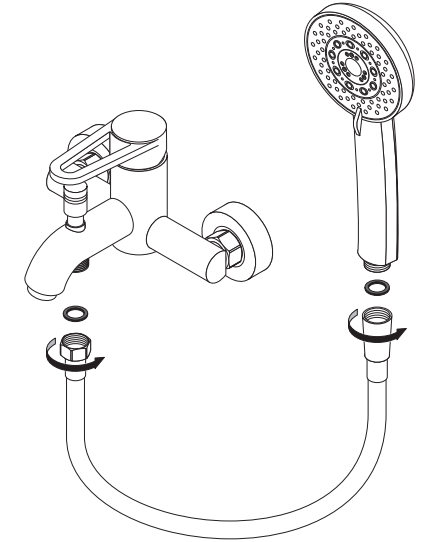
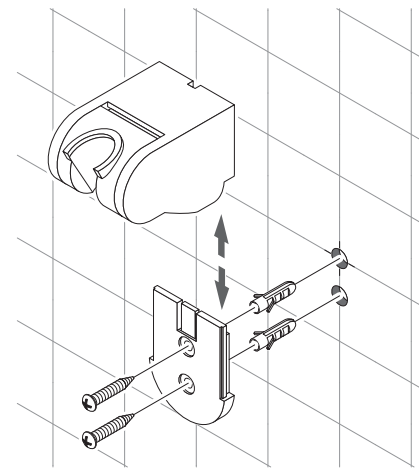

- 6 Turn on the faucet and diverter, check for leakage.

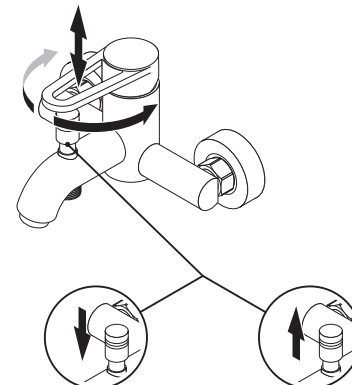

- 7 Do not touch here when it is working.

